

**INSTRUCTIONS MANUAL
INDICATOR FOR PROCESS CONTROL**



TYP 9186-VX0XX

CODE: 30727260 EDITION: 27-06-2011



DECLARATION OF CONFORMITY

Applicable Standards : **EN50081-1** Generic emission
EN55022/CISPR22 Class B

Applicable Standards : **EN50082-1** Generic immunity
IEC1000-4-2 Level 3 Criteria B
Air Discharge 8kV
Contact Discharge 6kV

IEC1000-4-3 Level 2 Criteria A
3V/m 80..1000MHz

IEC1000-4-4 Level 2 Criteria B
1kV Power Lines
0.5kV Signal Lines

Applicable Standards : **EN61010-1** Generic Safety
IEC1010-1 Installation Category II
Transient Voltages <2.5kV
Degree of Pollution 2
Conductive pollution excluded
Insulation type
Enclosure : Double
Inputs/Outputs : Basic

DIGITAL PANEL INSTRUMENT

Typ 9186-VX0XX

INDEX

1 . MODELS Typ 9186-VX0XX OVERVIEW	4-5
1.1. – FRONT-PANEL DESCRIPTION	6-7
2 . SETUP AND OPERATION	8
2.1 – POWER SUPPLY AND CONNECTORS	9-10
2.2 – PROGRAMMING INSTRUCTIONS	11
2.3 – INSTRUMENT SETUP	12
2.4 – INPUT CONNECTION	13-14
2.5 – INPUT CONFIGURATION	15
2.6 – DISPLAY CONFIGURATION	16-18
2.7 – SETPOINTS CONFIGURATION	19-21
2.8 – PROGRAMMING LOCKOUT	22
3 . SETPOINTS OPTION	23
4 . TECHNICAL SPECIFICATIONS	24
4.1 - DIMENSIONS AND MOUNTING	25
5 . WARRANTY	26

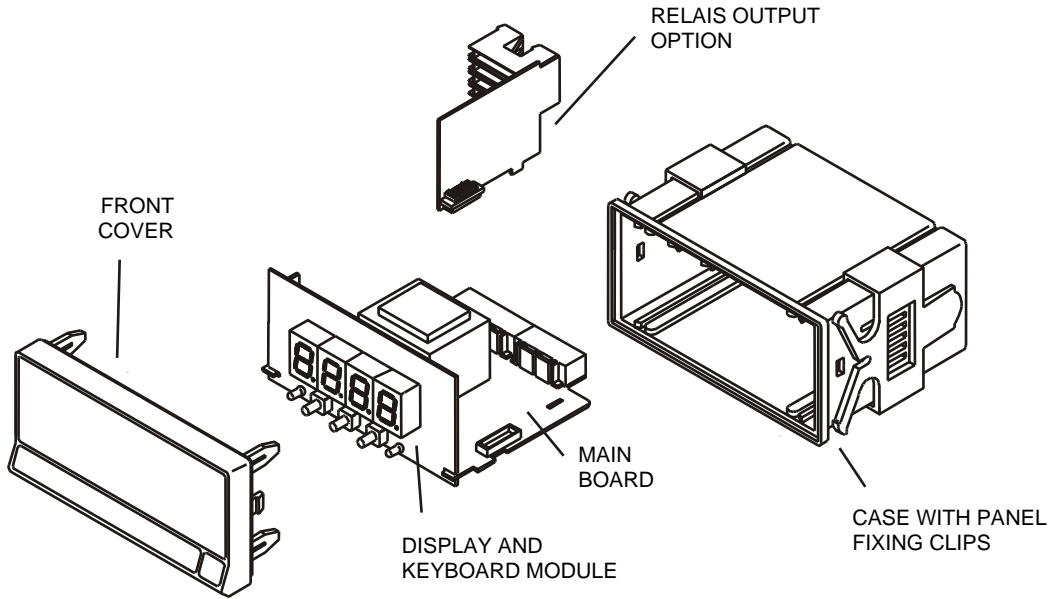

1. TYP 9186-VX0XX

This manual describes the models Typ 9186-VX0XX

Model Typ 9186-VX0XX provides 20mm-high digits which make it easy readable at long distances. In this manual both models are referred with the generic name of Typ 9186-VX0XX.

The models Typ 9186-VX0XX are designed specially to measure process signals coming from transducer with signals like 4-20mA or 0-10V. The instrument gives 24V DC supply for transducers excitation or 10V for **Potentiometer**.

Software configuration allows input type selection.

Two programming modes allow scaling the display to match desired units.

The basic instrument is a soldered assembly composed of the main board, and the display and keyboard module.

Optionally, it can be equipped with a 2-relay control output card. This option provides an output connector at the rear of the meter, status LED's visible from the front and specific programming routines which are enabled automatically once the card is installed.

The outputs are isolated from signal input and power supply.



This instrument conforms the following community standards: 89/336/CEE and 73/23/CEE
WARNING: Refer to the instructions manual to preserve safety protections.

FRONT-PANEL FUNCTIONS DESCRIPTION (RUN MODE)

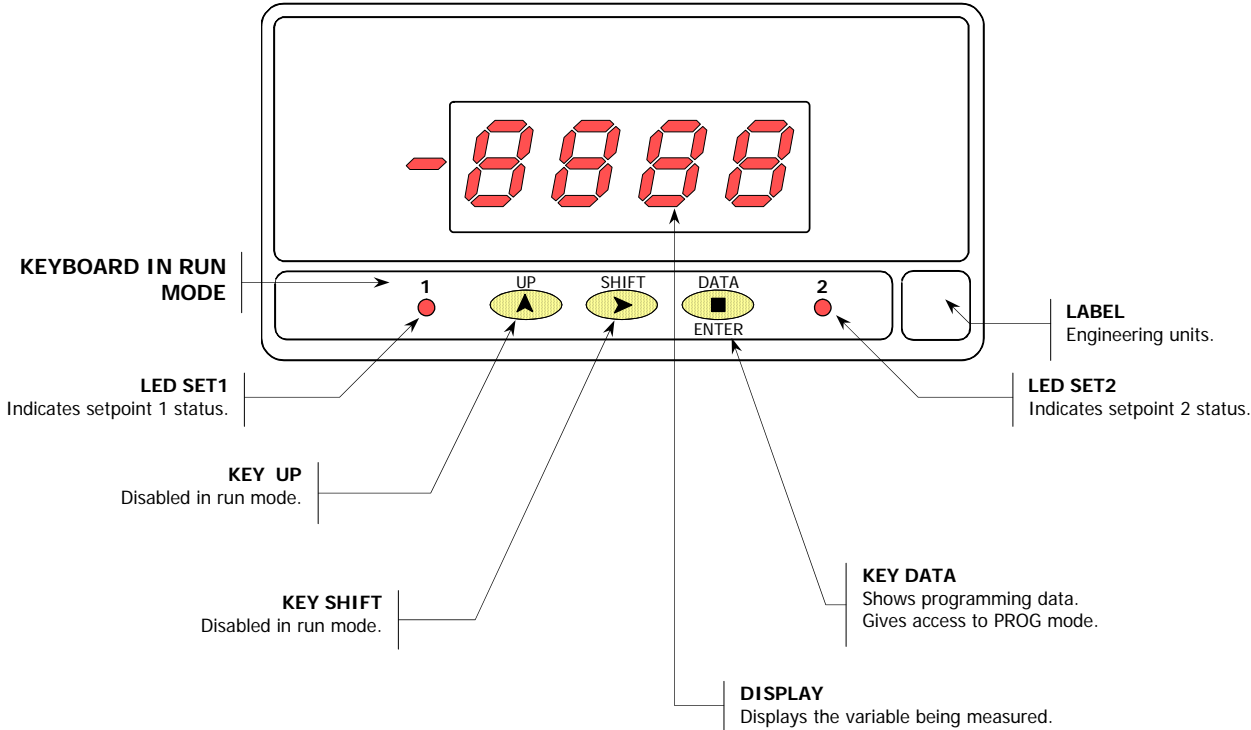

FRONT-PANEL FUNCTIONS DESCRIPTION (PROG MODE)

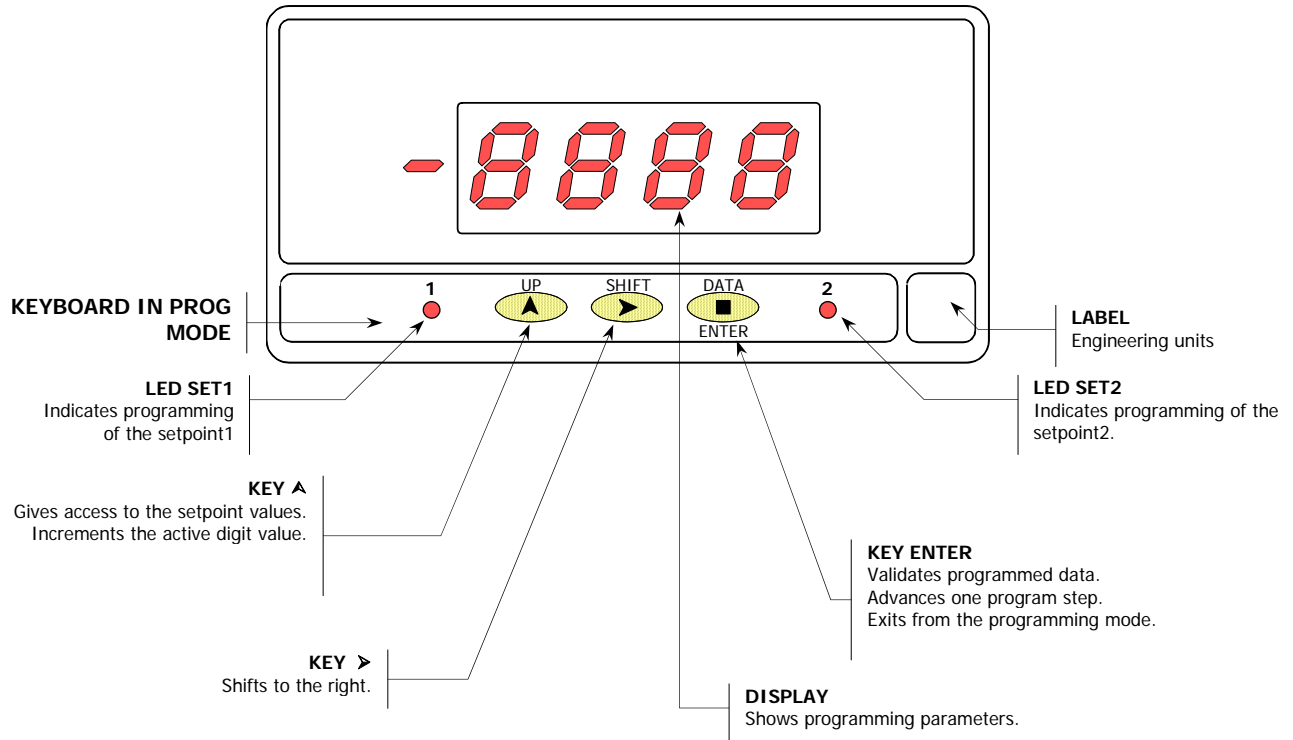

2. OPERATING INSTRUCTIONS

PACKING CONTENTS

- ❑ Instructions manual in English
 - ❑ The digital panel instrument Typ 9186-VX0XX.
 - ❑ Accessories for panel mounting (sealing gasket and fixing clips).
 - ❑ Accessories for wiring connection (removable terminal block connectors and fingertip).
 - ❑ Wiring label stuck to the instrument's case
 - ❑ Set of 4 labels with different engineering units.
- ✓ ***Check packing contents.***

CONFIGURATION

Power supply (pages 9 & 10)

- ❑ The instruments for 115/230V AC power supply, are set up at the factory for 230V AC. (USA market 115 V AC).
 - ❑ The instruments for 24/48V AC power supply, are set up at the factory for 24V AC.
 - ❑ If the instrument is supplied for 12V DC, 24V or 48V DC power supply, it is not necessary to make any change.
- ✓ ***Check wiring label before connecting the instrument to the supply.***

Programming instructions (page 11)

- ❑ The software inside the instrument allows configuring the input parameters. If a two-relay output option is installed, the software detects it on power up enabling a specific routine for setpoints configuration.
- ✓ ***Read carefully this paragraph.***

Input type (page 12-15)

- ❑ The instrument provides an input for process signals from transducers with output levels of $\pm 10V$ DC or $\pm 20mA$. In addition the instrument supply 24V DC for transducer excitation.
- ✓ ***Check transducer type and signal level.***

Programming lockout (page 22)

- ❑ As shipped from the factory, the instrument allows full access to change programming parameters. To disable the possibility of making changes on the configuration, it is necessary to remove a plug-in jumper located on the main board.
- ✓ ***Check jumper position.***

2.1 – Power supply and connectors

To change the meter's physical configuration remove the case as shown in figure 9.1.

115/230 V AC: The instruments with 115/230 V AC power are set up at fabrication for 230 V AC (USA market 115 V AC), see figure 9.2. To change power supply configuration to 115 V AC, make the jumpers indicated in figure 9.3 and table 1. The wiring label should be modified to match the new configuration.

24/48 V AC: The instruments with 24/48 V AC power are set up at fabrication for 24 V AC, see figure 9.2. To change power supply configuration to 48 V AC, make the jumpers indicated in figure 9.3 and table 1. The wiring label should be modified to match the new configuration.

12, 24 or 48V DC:
Instruments for DC power are set up for the supply voltage specified in the wiring label (12V, 24V or 48V according to the order reference).

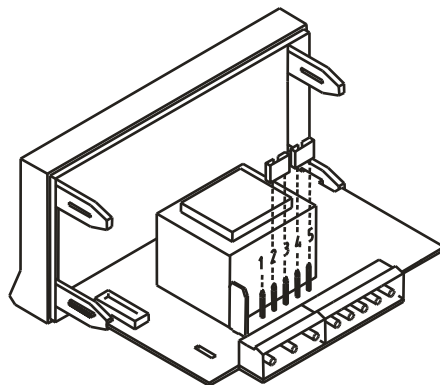

Fig. 9.2. Jumper settings for 230 V or 48 V AC

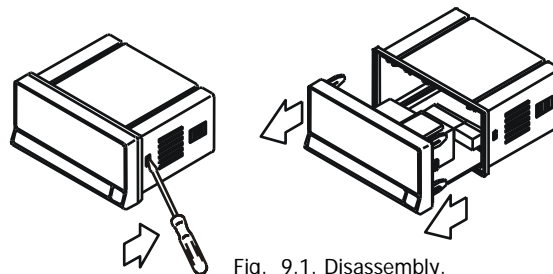

Fig. 9.1. Disassembly.

Tabla 1. Jumper settings

Pin	1	2	3	4	5
230V AC	-	—	—	—	—
115V AC	—	—	—	-	-
48V AC	-	—	—	—	-
24V AC	—	—	—	-	-

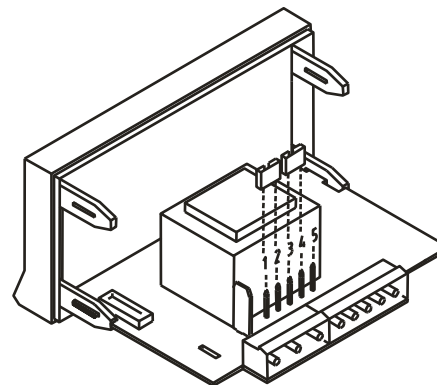
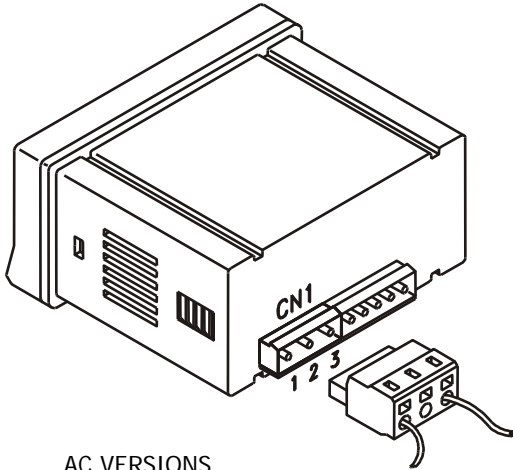

Fig. 9.3. Jumper settings for 115 V or 24 V AC

POWER CONNECTION



AC VERSIONS

PIN 1 – AC PHASE
PIN 2 – GND (GROUND)
PIN 3 – AC NEUTRAL

DC VERSIONS

PIN 1 – DC POSITIVE
PIN 2 – Not connected
PIN 3 – DC NEGATIVE



INSTALLATION

To meet the requirements of the directive EN61010-1, where the unit is permanently connected to the mains supply it is obligatory to install a circuit breaking device easy reachable to the operator and clearly marked as the disconnect device.

WARNING

In order to guarantee the electromagnetic compatibility, the following guidelines should be kept in mind :

- Power supply wires may be routed separated from signal wires. Never run power and signal wires in the same conduit.
- Use shielded cable for signal wiring and connect the shield to the ground of the indicator (pin2 CN1).
- The cables section should be $\geq 0.25 \text{ mm}^2$

If not installed and used in accordance with these instructions, protection against hazards may be impaired.

CONNECTORS

To perform wiring connections, remove the terminal block from the meter's connector, strip the wire leaving from 7 to 10mm exposed and insert it into the proper terminal while pushing the fingertip down to open the clip inside the connector as shown in the figure.

Proceed in the same manner with all pins and plug the terminal block back to the corresponding meter's connector.

Each terminal can admit wires of section between 0.08 mm^2 and 2.5 mm^2 (AWG 26 ÷ 14).

Some terminals have removable adaptors to provide proper fastening for wires of sections less than 0.5 mm^2 .

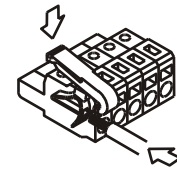

2.2 – Programming Instructions

To enter in the programming mode

Connect the meter to the main supply, for approx. 1s a self-test routine automatically activates all the digits of the display. After, the instrument goes to the normal operating mode (RUN).

To enter in the programming mode press for 5 seconds until the indication **Pro** shown in figure 11.1 appears on the display.

To exit from the programming mode

To return to the run mode, it is necessary to pass through the different menu steps by successively pressing the **ENTER** key until the meter displays the indication **Stor** while internally stores the programmed parameters into the memory. After, it automatically goes to the normal operating mode.

How to interpret the programming instructions

The programming software routine is composed by a series of hierarchically organized menus, each allowing the setting of a specific parameter. In general, the normal sequence at each step is to push the **▶** key a number of times to make changes and the **ENTER** key to store them in the memory and advance to the next step.

The elements used along the programming instructions are described following.

[11.1] Programming Method

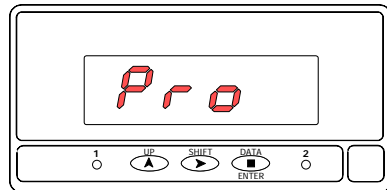

The programming instructions for each menu step are accompanied by a figure representing the display indication for the corresponding parameter. Pay special attention to the LED indications and active keys and follow the procedure described on the text to introduce correctly the desired data.

When the display indication is represented with blank segments, it means that this is one of the possible options of this menu (normally the default one) depending on the previous selection.

A series of blanked '8' represents any numerical value that can be changed by use of keys **▶** (change digit) and **▶** (change value).

2.3 - Instrument setup

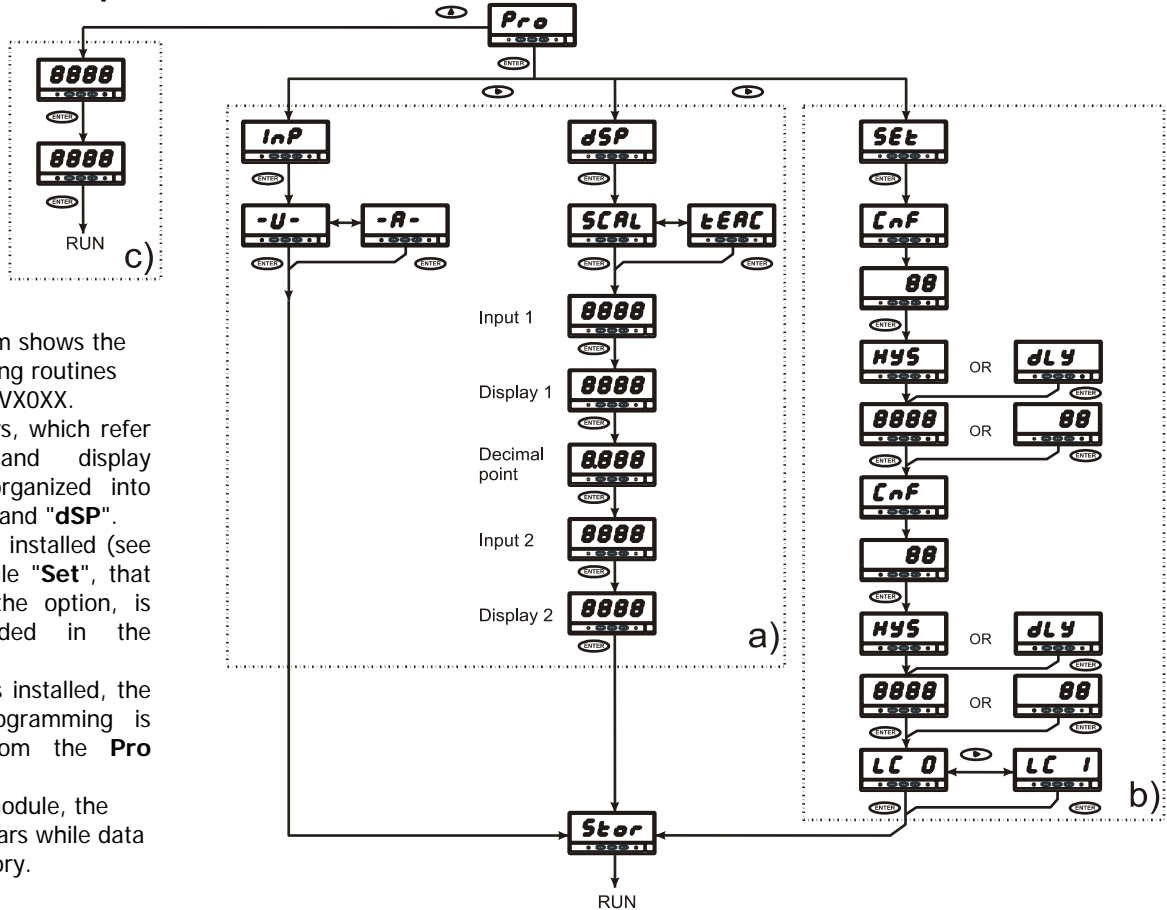

The enclosed diagram shows the complete programming routines for models Typ9186-VX0XX. The basic parameters, which refer to the input and display configuration are organized into two modules: "InP" and "dSP". If a 2-relay option is installed (see page 20), the module "Set", that allows configuring the option, is automatically included in the routines. If a 2-relay option is installed, the setpoint values programming is directly entered from the **Pro** stage. At the end of each module, the indication **Stor** appears while data is saved in the memory.

2.4 – Input signal connection

Refer to the transducer's specifications and to the wiring advisements given in page 10.

SIGNAL CONNECTION (CN2)

PIN 1 = -IN (signal negative, V/mA)
 PIN 2 = +IN [V] (signal positive, V)
 PIN 3 = +IN [mA] (signal positive, mA)
 PIN 4 = +EXC (excitation positive) 24V or 10V
 PIN 5 = -EXC (excitation negative)

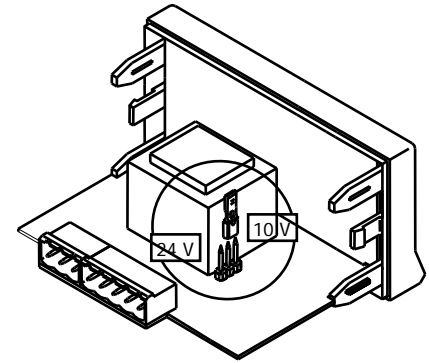
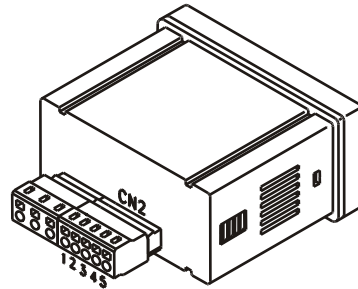

EXCITATION VOLTAGE SELECTION: 24 V or 10 V

Signal wiring schematics for transducers with voltage output

CONNECTION WITH EXTERNAL EXCITATION

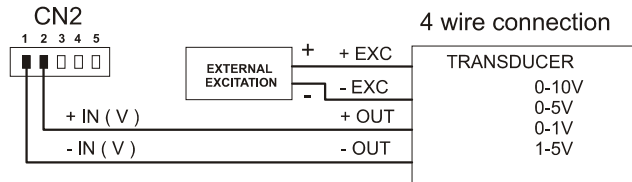

EXCITATION SUPPLIED BY Typ9186-VX0XX

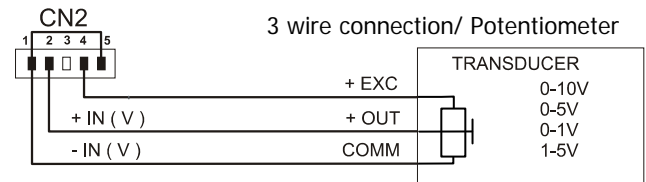
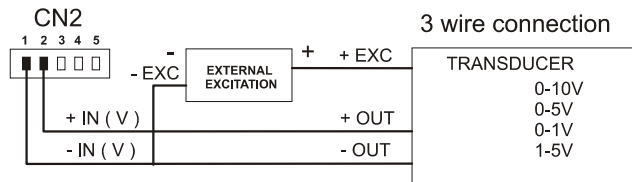
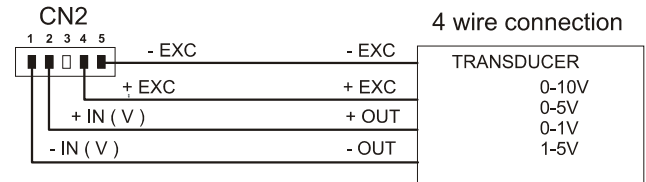

Signal wiring schematics for transducers with current output

CONNECTION WITH EXTERNAL EXCITATION

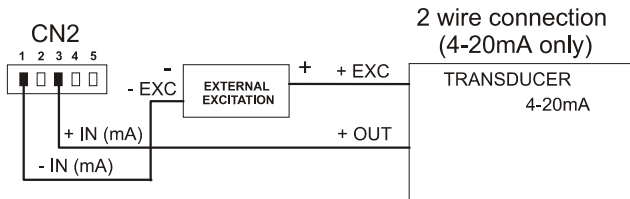
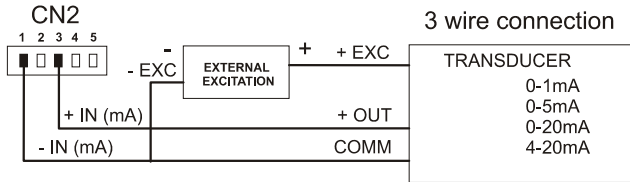
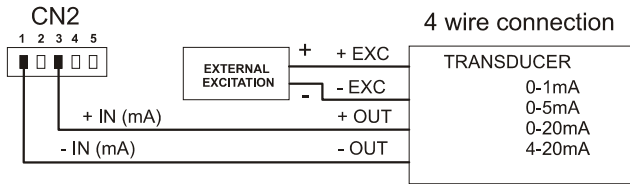

EXCITATION SUPPLIED BY Typ9186-VX0XX

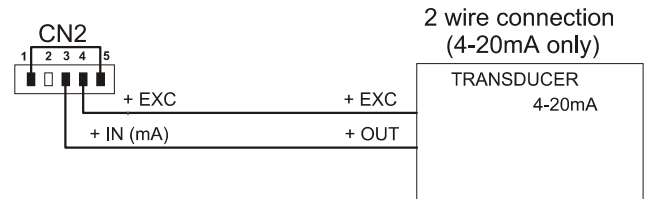
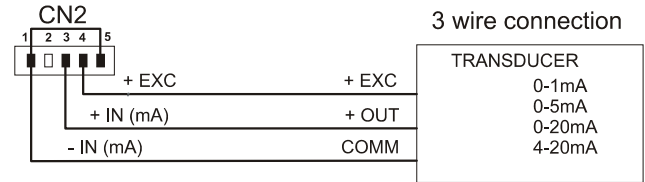
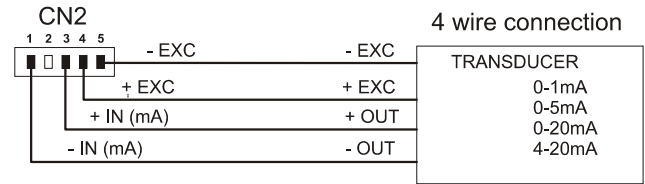

ACCESS TO THE PROGRAMMING MODE

[15.1] Programming mode

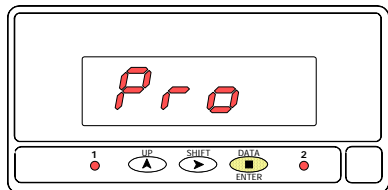

Connect the instrument to the main supply, it automatically enters in a self-test routine which briefly illuminates all segments and LED's then shows the software version and finally goes to the normal reading ("RUN" mode).

Press **ENTER** to access the programming mode.

The display shows the indication given in fig. 15.1. The LED's 1 and 2 will flash during the programming mode (except when programming the setpoints).

Press **ENTER** to have access to the programming parameters.

2.5 - Input configuration

[15.2] Input Module

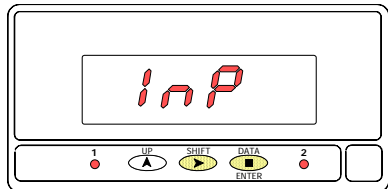

Press **ENTER** to access to the input configuration module (fig. 15.2).

Other modules (dSP = display, and, if option installed, SEt = setpoints) are selected by pressing the **SHIFT** key.

[15.3] Input type

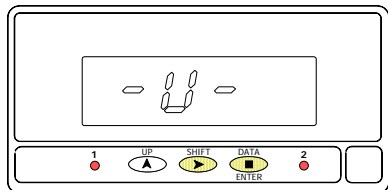

The display shows the indication corresponding to the previously selected input type (see fig. 15.3). Available options are -U- = voltage input (volts) and -A- = current input (milliamperes) which alternate on the display by successively pressing the **SHIFT** key. When desired option is presented on the display, press **ENTER** to validate the choice and return to the run mode. The indication Stor is viewed while data is being saved in the memory.

2.6 – Display Configuration

After the input configuration it is necessary to program the display range to adapt the meter to the particular application in the desired units.

Scaling the display consist on programming two points by introducing two input values (INP1, INP2) and their corresponding display values (DSP1, DSP2). The decimal point position will complete the indication in the required engineering units. For the best accuracy, both points 1 and 2 should be approximately the process limits.

It is possible to set up the scale so that the display varies in reverse proportion to the input signal. This is accomplished by programming the high display for the low input and the low display for high input. The figure shows how to program points 1 and 2 direct or reverse operation.

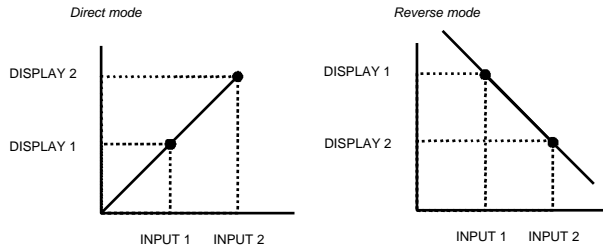

Direct mode:

- If input signal *increases* display reading *increases*.
- If input signal *decreases* display reading *decreases*.

Reverse mode:

- If input signal *increases* display reading *decreases*.
- If input signal *decreases* display reading *increases*.

In programming menus for display configuration first will be introduced the input and display for point 1, next the decimal position and finally the input and display for point 2.

When introducing the input values the decimal point position is automatically adjusted to get the best possible resolution.

The decimal point should be placed on any desired position and this position will remain during the rest of steps of programming or when working. If the most right position has been choose when the instrument is working the decimal point doesn't 't appears.

[17.1] Display Module

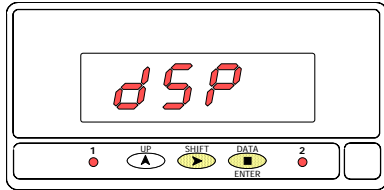

From the Pro stage (see fig. 17.1), press **ENTER** to access to the different configuration modules (InP = input, dSP = display, and, if option installed, SET = setpoints). Select the display module by a press of **▶** (the indication given in figure 17.1 appears on the display).

Press **ENTER** to enter this module.

[17.2] Scaling method

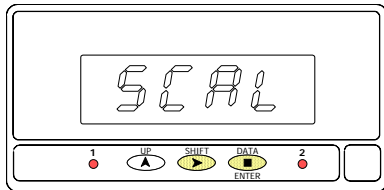

The first step of this module is to select the scaling method (a description of each method is given in page 16). The display shows the previously selected method which can be changed by means of the **▶** key [**SCAL** = by key-in, **tEAC** = by applying signal levels]. When desired option is present on the display press **ENTER** to validate and advance to the next step.

[17.3] Input 1

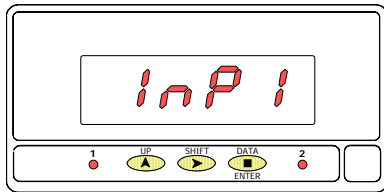

The indication "InP1" (fig. 17.3) is viewed for 2s before giving access to the programming of the input value for point 1 (InP1). Depending on the selected scaling method, the input value is programmed in one of the following ways:



- **SCAL method.** The previously programmed value appears on the display with the first digit in flashing. To change this value (allowable range is -1999 to 9999), use the **▲** key to increment the active digit value and the **▶** key to go to the next digit to be modified. Repeat these operations with all digits until desired InP1 value is registered on the display and press **ENTER**.
- **tEAC method.** Brings the process to the conditions of point 1. The display reads the actual input value present at the input connector. To accept this value as InP1 press **ENTER**.

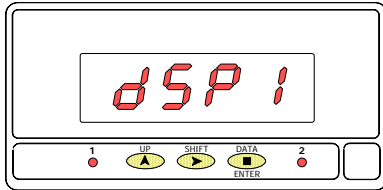

[18.1] Display 1



The indication "dSP1" (fig. 18.1) is viewed for 2s before giving access to the programming of the display value for point 1 (dSP1).

The previously programmed value appears on the display with the first digit in flash.

To change this value, use the  key to increment the active digit value and the  key to go to the next digit to be modified. Repeat these operations with all digits until desired dSP1 value is registered on the display and press .

The decimal point flashes to indicate that it can be moved at this step. Press repeatedly the  key to move it to the right until it takes desired location. If no decimal point is required, it must be placed to the rightmost digit of the display. Press  again to validate programmed data and go to the next step.

[18.2] Input 2

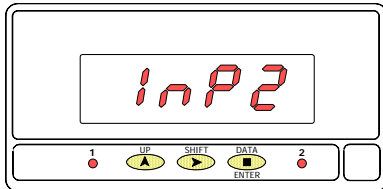

The indication "InP2" (fig. 18.2) is viewed for 2s before giving access to the programming of the input value for point 2 (InP2).

The procedure for programming this parameter is the same as described in section 17.3.

[18.3] Display 2

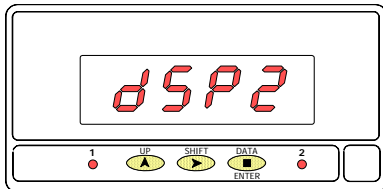



The indication "dSP2" (fig. 18.3) is viewed for 2s before giving access to the programming of the display value for point 2 (dSP2).

The display shows the previously programmed value with the first digit in flashing. To change this value follow the procedure described in section 18.1. The decimal point is fixed in the position selected in section 18.1. Press  to validate changes and return to the run mode. The indication **Stor** is viewed while data is being saved in the memory.

2.7 Setpoint configuration (accessible if 2RE option is installed)

If a two relay option is installed (see page 23) the instrument will allow to enter on the following routines: activation mode, delay or hysteresis and setpoint program lockout.

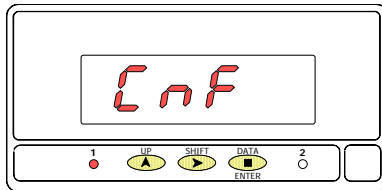

From programming mode (Pro stage, see fig. 15.1), press  key to access to the setpoint configuration, indication "SET". To program the setpoint numerical values, from the run mode press  to call the **Pro** stage and press  to access the first setpoint value.

[19.1] Setpoint 1 Configuration



LEFT DIGIT VALUE	RIGHT DIGIT VALUE
MODE HI=0	DELAY=0
MODE LO=1	HYSTERESIS=1





The indication shown in figure 19.1 appears on the display to indicate that the next step is to program the setpoint1 operating parameters (led Setpoint 1 activated). After 2 seconds or by a press  , the meter allows access to this menu.

The display then shows two digits: the leftmost one corresponds to the output mode (HI or LO) and the rightmost one corresponds to the delay unit (time -delay- or counts of display -hysteresis-) according to the table below the figure. Use the  key to change the active digit value (in flashing) and the  key to go to the next digit to be set.

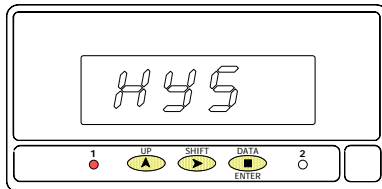
Press  to validate selections and advance to the next phase.

[19.2] SET1 Hysteresis/Delay



Depending on previous phase choice, the display will show for 2 seconds the indication corresponding to the selected delay units before giving access to the time delay or hysteresis magnitude programming (**dLY**) or (**HYS**). After 2 seconds or by a press of  , the initially programmed numerical value appears on the display with the first digit in flashing. To program the desired value (from 0 to 9999 counts of hysteresis or from 0 to 99 seconds of time delay) use the  key to increment the active digit value and the  key to advance to the next digit to be modified. Repeat this procedure until desired value is completed on the display and press  to validate and access to the programming of the setpoint 2 parameters.

[20.1] Setpoint 2 Configuration

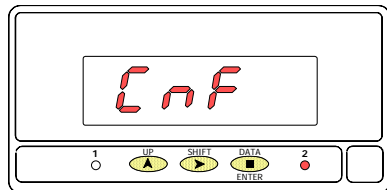

LEFT DIGIT VALUE	RIGHT DIGIT VALUE
MODE HI=0	DELAY=0
MODE LO=1	HYSTERESIS=1

The indication shown in figure 20.1 appears on the display to indicate that the next step is to program the setpoint 2 operating parameters (led Setpoint 2 activated). After 2 seconds or by a press **ENTER**, the meter allows access to this menu.

The display then shows two digits; the one on left corresponds to the output mode (HI or LO) and the rightmost one to the delay unit (time -delay- or counts of display -hysteresis-). See table in figure 20.1. Use the **▲** key to change the active digit value (in flashing) and the **▶** key to go to the next digit to be modified.

Press **ENTER** to validate changes and advance to the next phase.

[20.2] SET2 Histeresis/Delay

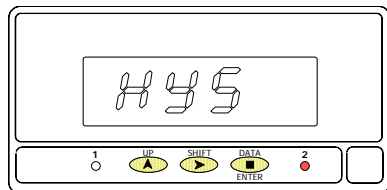

The display shows for 2 seconds the indication corresponding to the selected delay units before giving access of the time delay or hysteresis magnitude programming (**dLY**) or (**HYS**). After 2 seconds or by a press **ENTER**, the initially programmed numerical value appears on the display with the first digit in flashing. To change the value (from 0 to 9999 counts of hysteresis or from 0 to 99 seconds of time delay) use the **▲** key to increment the active digit value and the **▶** key to advance to the next digit to be modified. Repeat this procedure until desired value is completed on the display and press **ENTER** to validate and advance to the next step.

[20.3] Setpoint Program lockout

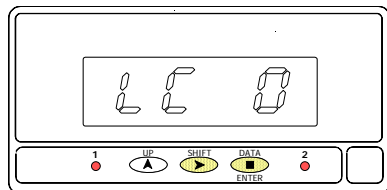

The figure 20.3 shows one of the two options available at this stage [**LC 0** = setpoint values programming enabled (unlocked) or **LC 1** = setpoint values programming disabled (locked)].

If wanted to modify this parameter, use the **▶** key to switch to the desired option. If you decide to lock the setpoint values, it will be also necessary to lock out the entire program routines (see page 22).

Press **ENTER** to validate the choice, save programmed data and return to the run mode (indication **Stor**).

[21.1] Setpoints Programming

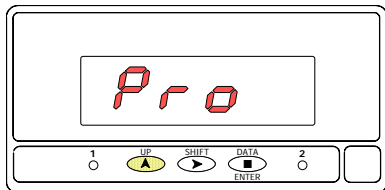

To program the setpoint values, press **ENTER** to access the programming mode (indication **Pro**, figure 21.1) and press **▲** to make the display show the previously programmed value of setpoint 1.

NOTE: The setpoint values should be programmed within the selected measurement range.

[21.2] Setpoint 1

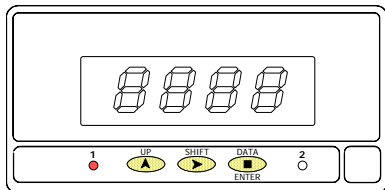

Program setpoint 1 value, LED 1 activated.

The initially programmed value appears on the display with the first digit flashing. Press repeatedly the **▲** key to increment the active digit value until it takes the desired value and press **▶** to advance to the next digit to be modified. Repeat these operations to complete the desired setpoint value with sign.

Press **ENTER** to validate the entry and pass to the programming of setpoint 2.

[21.3] Setpoint 2

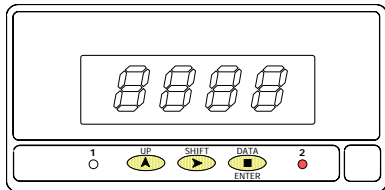

Program setpoint 2 value, LED 2 activated.

Program the setpoint 2 value with sign by means of the **▲** (change value) and **▶** (change digit) procedure as described in previous phase.

Press **ENTER** to store programmed data in the memory and exit from the programming mode.

2.8 – Programming lockout

After completing the instrument's programming, it is recommended to lockout the access to the programming to prevent from accidental or unauthorized modifications.

This operation is made by taking off a plug-in jumper located on the main board circuit (see figure at right).

NOTE : Disconnect power before changing the jumper position.

While the instrument is locked out it is however possible to access to the programming routines to check the current configuration, but it won't be possible to entry or modify data. In this case, a push of **ENTER** to access the programming routines will show the indication **dAtA** instead of **Pro**.

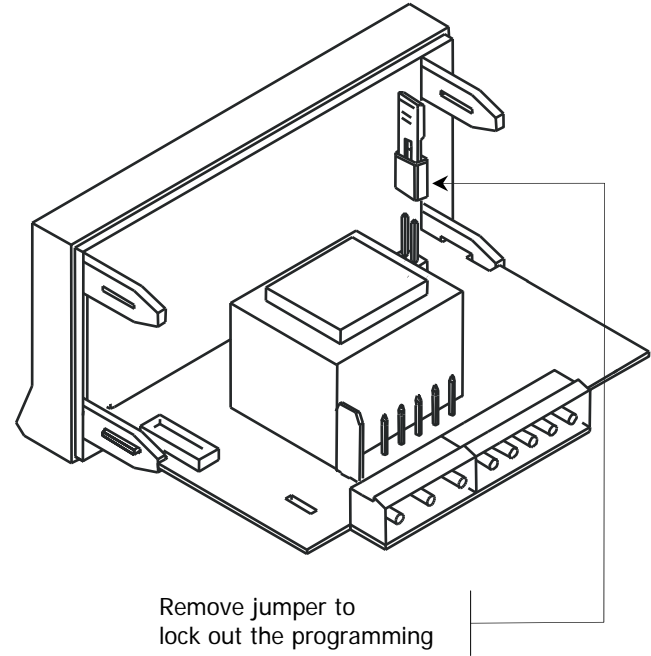

3. RELAY OUTPUT OPTION

As an option, the Typ 9186 models can be equipped with the following output option:

- A control output card with two SPDT relay outputs rating 8 A @ 250 V AC / 150 V DC. The outputs can be programmed for HI or LO operation and selectable time delay or hysteresis action.

The 2RE option consists of an additional card installable to the meter's main board by means of a plug-in connector.

The option is supplied with a specific instructions manual describing installation and characteristics. Nevertheless, the programming instructions are given in the Typ 9186 manual.

For more detailed information on characteristics, applications and mounting, please refer to the specific instructions manual

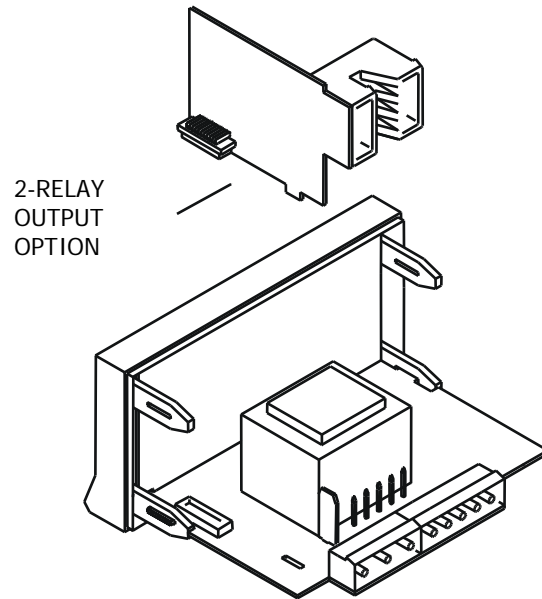

4. TECHNICAL SPECIFICATIONS

INPUT SIGNAL

- Configuration differential asymmetrical
- **INPUT TYPE** **VOLTAGE** **CURRENT**
- Input ± 10 V DC ± 20 mA DC
- Max. resolution 1 mV 10 μ A
- Input impedance 2 M Ω 12.1 Ω
- Excitation 10 V $\pm 0,1$ V/ 20 V ± 5 V @30mA

ACCURACY

- Max. error \pm (0.1% of the reading +3 digits)
- Temperature coefficient 100 ppm/ $^{\circ}$ C
- Warm-up time 5 minutes

POWER SUPPLY

- AC voltages 230/115 V, 24/48 V ($\pm 10\%$) 50/60 Hz AC
- DC voltages 12V (10.5-16 V), 24V (21-32 V), 48V (42-64V)
- Power consumption 3 W

FUSES (DIN 41661) - (Recommended)

- Typ 9186-V0000 (230/115V AC) F 0.1A / 250 V

A/D CONVERSION

- Technique Sigma-Delta
- Resolution 16 bits
- Rate 25/ s

DISPLAY

- Typ 9186 von -1999 bis 9999 Rote, 4-stellige 20 mm
- Decimal point programmable
- LEDs 2 for output status
- Reading rate 250 ms
- Display over range OvE
- Input over range OvE

ENVIRONMENTAL

- Indoor use
- Operating temp. -10 $^{\circ}$ C to 60 $^{\circ}$ C
- Storage temperature -25 $^{\circ}$ C to +85 $^{\circ}$ C
- Relative humidity, non condensing <95 % at 40 $^{\circ}$ C
- Altitude max. 2000 m

MECHANICAL

- Dimensions 96x48x60 mm
- Panel cut-out 92x45 mm
- Weight 250 g
- Case material UL 94 V-0 polycarbonate

4.1 - Dimensions and mounting

To install the instrument into the panel, make a 92x45mm cut-out and insert the instrument from the front placing the sealing gasket between this and the front bezel.

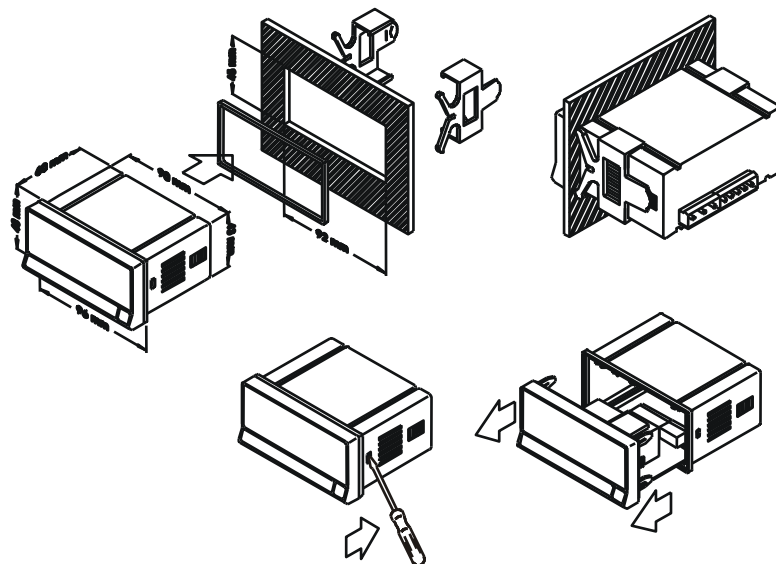
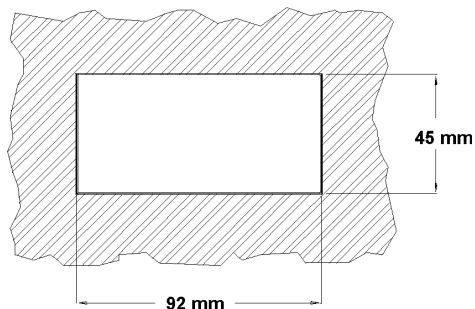

Place the fixing clips on both sides of the case and slide them over the guide tracks until they touch the panel at the rear side. Press slightly to fasten the bezel to the panel and secure the clips.

To remove the instrument from the panel, pull outwards the fixing clips rear tabs to disengage and slide them back over the case.

CLEANING: The front cover should be cleaned only with a soft cloth soaked in neutral soap product.
DO NOT USE SOLVENTS

